

Docks and Decks

Market Solutions



Building the World to Last[®]

HIGH PERFORMANCE COMPOSITE SOLUTIONS

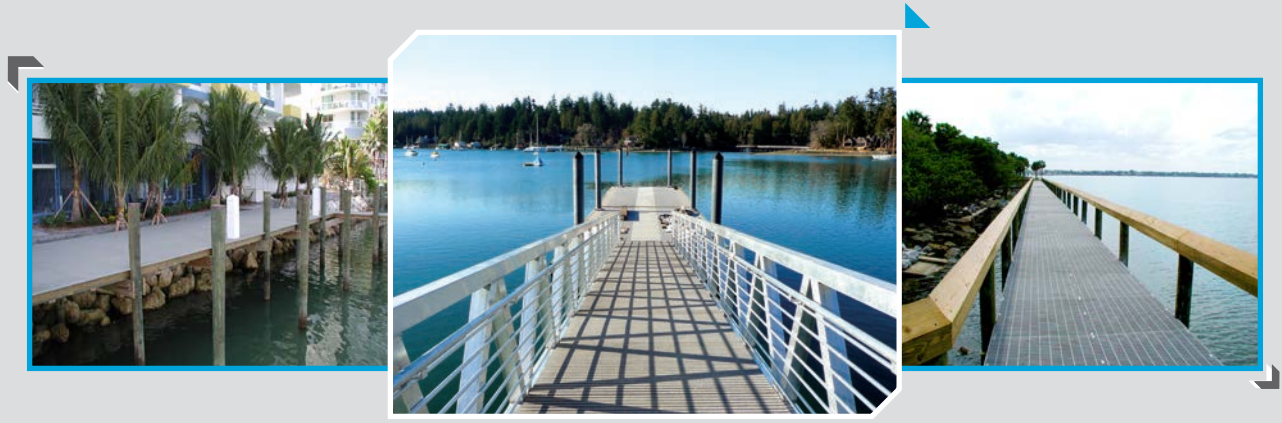

Together, we will make your vision a reality.

Fibergrate Docks and Decks

Fibergrate Composite Structures is the originator of moulded Glass Reinforced Plastic (GRP) grating. Fibergrate continues to lead the industry in innovative products and the ability to provide customized solutions for numerous applications and industries. In our history of 50+ years, Fibergrate has provided many products to marine, recreational, and commercial customers. Now as our nation has become more knowledgeable about our marine environments, we have committed to producing products that will provide the best solution for our customer and the environment.

Fibergrate has multiple products to consider when building a dock, boardwalk, pier or deck. Aquagrate® is an extremely durable, pultruded pedestrian grating equipped with 1-1/2 inch bearing bars and a fine grit called Sugargrit. This combination makes Aquagrate the perfect option for providing comfort and safety for barefoot pedestrians.



Micro-Mesh® is another good option, partly due to its elegant look, bidirectional strength, and minimal requirement for maintenance. Like the Aquagrate, Micro-Mesh is barefoot-friendly, slip-resistant and can be used in a wide variety of applications. Micro-Mesh also satisfies the requirements of both the Americans with Disabilities Act and the Army Corps of Engineers. Because of its easy installation, Micro-mesh can be installed quickly and cost effectively.

For situations where the environment is a primary concern, Ecograte® moulded grating is often the best option. Because of its 46% open area, it not only exceeds the requirements of the Army Corps of Engineers, but can be installed without effecting the existing ecosystem. Coated with Aquagrit, the surface of Ecograte is safe and comfortable for barefoot pedestrians.

Since Fibergrate's inception we have prided ourselves on creating custom solutions, and we have built a wide range of structures. We are confident that whatever your vision may be, we can offer a solution that fits your criteria. All of our products are corrosion-resistant, require very little maintenance, and can be easily installed.

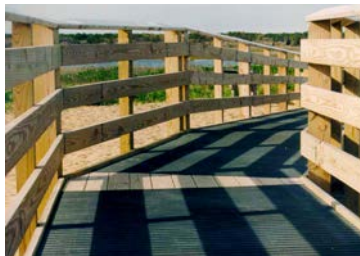

GRP Benefits



Corrosion-Resistant: More than 15 premium grade resin systems available to meet your needs. This unmatched protection is ensured by the manufacturing process in which fibreglass is thoroughly wetted, providing continued structural integrity in tough environments.



Slip-Resistant: The meniscus and integrally applied grit surfaces of Fibergrate grating products have unmatched slip resistance for improved worker safety.



Low Maintenance: The corrosion-resistant properties of GRP grating and other products reduce or eliminate the need for sandblasting, scraping and painting. Products are also easily cleaned with a high pressure washer.



Fire-Retardant: Flame spread rating of 25 or less, as tested in accordance with ASTM E-84, and meets the self-extinguishing requirements of ASTM D-635.



High Strength to Weight Ratio: Less than one-half the weight of steel grating, allowing easy removal for access below floor level and installation with no heavy equipment and less manpower.



Electrically & Thermally Non-Conductive: Fibreglass is electrically non conductive for safety and has low thermal conductivity which results in a more comfortable product when physical contact occurs.



Impact-Resistant: Can withstand major impacts with negligible damage. Gratings are available to satisfy even the most stringent impact requirements.



UV-Resistant: Fibergrate's GRP gratings are formulated for maximum UV resistance and a special coating is available for increased UV resistance on handrail and ladder systems.

- **Easily Fabricated:** Can be cut using circular or reciprocating saws with abrasive blades.
- **Engineering and Drafting:** Some chemical projects require sealed drawing and calculations. Utilizing Fibergrate's 50+ years experience and engineering directed by a professional engineer can save time and money from concept to completion.



NSF® Standard 61-Certified:

Fibergrate offers a line of pultruded and moulded products that have been certified to NSF Standard 61 for potable water contact. These include Dynaform® structural shapes, Dynarail® ladder and handrail systems, as well as specially formulated moulded grating using an isophthalic and vinyl ester resin formulation, the only moulded gratings available with NSF Standard 61 certification.



Heavy Metal Safe:

The EPA, OSHA and other regulatory agencies created to protect our lives and our natural resources have increased legislation to control heavy metals such as lead, chrome, cadmium and other metals in all products where exposure is a health threat. Fibergrate Composite Structures Inc. supports this strengthened legislation and has, for more than 20 years, voluntarily tested for heavy metals in our products and minimized or eliminated heavy metals from our products.

GRP vs. Steel: When comparing the price of Fibergrate Glass Reinforced Plastic (GRP) to metallics, consider: [Value = Price / Service Life](#)

Cost Factor	Traditional Metallic Materials	The Fibergrate® Advantage
Safety Cost	Slips and falls are the second leading cause of industrial accidents and one of the leading causes of death. Each lost work day can lead to a significant cost.	Fibergrate's slip-resistant surface dramatically reduce accidental slips making it the most cost-effective solution for minimizing worker accidents and lost workdays.
Initial Installation Cost	Up front, metallic components appear to be the most economical based on material cost alone. However, metallic materials require heavy lifting equipment, added labour for cutting, welding, painting and grating must be "edge-banded".	Although initial material investment may appear higher, don't be fooled! GRP products require no heavy lifting equipment, minimal labour, are easily fabricated with hand tools, do not need painting and grating require no edge-banding.
Maintenance & Replacement Cost	In highly corrosive chemical installations, metallic products often require intensive maintenance and often deteriorate in a few years or less requiring numerous replacements within the facility life.	Fibergrate GRP products will last much longer and require little maintenance. Fibergrate systems pay for themselves after one maintenance cycle. Many Fibergrate chemical installations have been in service for 30+ years.

Grating Comparison

Micro-Mesh® 1" Deep x 3/4" Sq Top Mesh

# of Bars/ Ft of Width	Load Bar Width	Open Area	Load Bar Centres	Approximate Weight
8	1/4"	44.4%	1.5"	2.9 psf

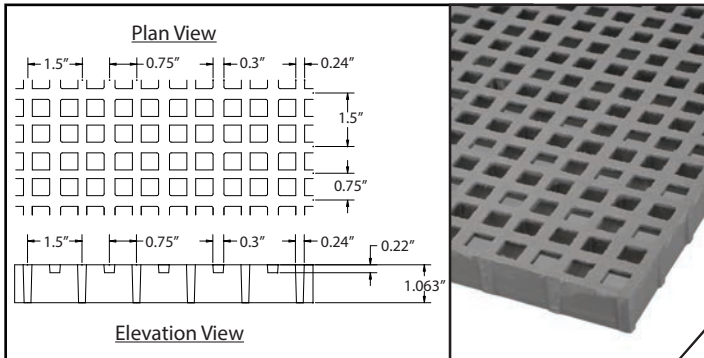

Section Properties per Ft of Width: $A = 2.34 \text{ IN}^2$ $I = 0.23 \text{ IN}^4$ $S = 0.37 \text{ IN}^3$

Ecograte® 1" Deep x 3/4" x 4"

# of Bars/ Ft of Width	Load Bar Width	Open Area	Load Bar Centres	Approximate Weight
16	1/4"	62%	3/4"	3.0 psf

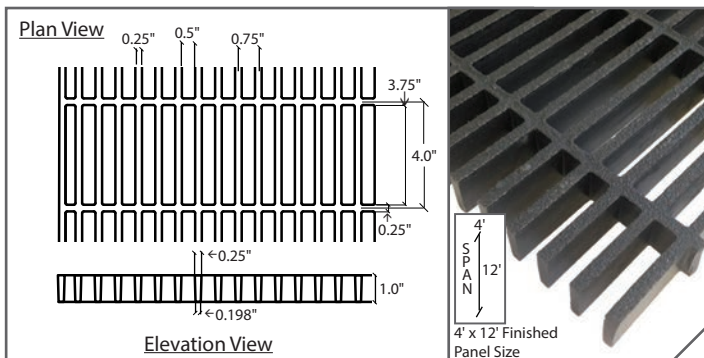

Section Properties per Ft of Width: $A = 3.58 \text{ IN}^2$ $I = 0.298 \text{ IN}^4$ $S = 0.573 \text{ IN}^3$

Fibergrate's Micro-Mesh® grating has an open area of 44.4% and exceeds guidelines set forth by the Army Corp of Engineers who require a minimum open area of 43%. The open area consideration is an important factor in protecting the seagrass as it allows light penetration through the dock. In addition, our square top mesh provides a maximum opening of 3/4" so it also meets the Americans with Disabilities Act (ADA) guidelines making it an excellent choice for public area applications. Offered in a 4' x 12' panel and depth options of 1" and 1-1/2", this bi-directional grating ensures a safe, a long lasting, easy to install and maintain solution.

Fibergrate's Ecograte® has an open area of 62% which exceeds the 60% minimum open area requirement set forth by the National Marine Fisheries Service and the U.S. Army Corps of Engineers for the Pacific Northwest for marine decking material light transmittance. The open area consideration is an important factor in protecting the seagrass and other shallow marine habitats as it allows light penetration through the dock. In addition, our golf tee-shaped bearing bars provide a minimum opening of 1/2" so it also meets the Americans with Disabilities Act (ADA) guidelines, making it an excellent choice for public area applications. The Aquagrit surface provides a barefoot-friendly, slip-resistant surface to ensure a safe deck area. Fibergrate's Ecograte products can be found at amusement parks and waterways around the world to provide a safe, long service life with low maintenance solutions.



Grating Comparison

Aquagrate® 1" Deep T1210 (ADA Compliant)

# of Bars/ Ft of Width	Load Bar Depth	Open Area	Load Bar Centres	Approximate Weight
7	1"	12%	1.714"	2.6 psf

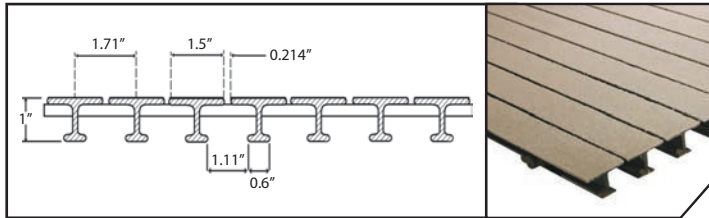

Section Properties per Ft of Width: $A=2.46 \text{ IN}^2$ $I=0.32 \text{ IN}^4$ $St=0.94 \text{ IN}^3$ $Sb=0.49 \text{ IN}^3$
Average $EI = 1,568,000 \text{ lb} \cdot \text{in}^2$ (SPAN $\geq 24'$)

Aquagrate® 1-1/2" Deep T1215 (ADA Compliant)

# of Bars/ Ft of Width	Load Bar Depth	Open Area	Load Bar Centres	Approximate Weight
7	1-1/2"	12%	1.714"	3.58 psf

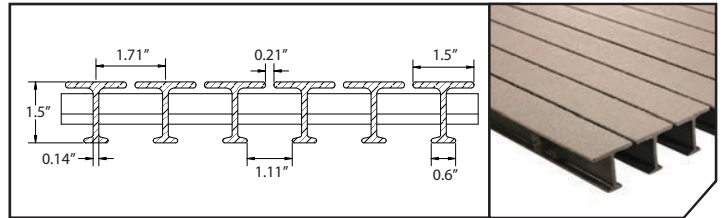

Section Properties per Ft of Width: $A=3.19 \text{ IN}^2$ $I=0.93 \text{ IN}^4$ $St=1.72 \text{ IN}^3$ $Sb=0.97 \text{ IN}^3$
Average $EI = 4,827,000 \text{ lb} \cdot \text{in}^2$ (SPAN $\geq 24'$)

Aquagrate® T1210 and T1215 pultruded pedestrian grating is specifically engineered to withstand the corrosive conditions associated with recreational and general marine applications and to meet ADA guidelines. With its nominal 1/4" space between the 1-1/2" wide bearing bars, Aquagrate offers optimum comfort and safety for bathers walking with bare feet - a must in high traffic public recreational areas. Aquagrate's unique combination of corrosion resistance and light weight provides easy, inexpensive installation in such facilities as swimming pools, water parks, marinas and piers.

Aquagrate is available in a variety of lengths and widths, making it useful for a number of waterfront and recreational applications. Aquagrate's Sugargrit surface provides a high level of slip resistance, yet at the same time offers a comfortable barefoot walking surface. Protection against long-term UV exposure is provided by a synthetic surfacing veil and UV inhibitors in the resin formulation. Whether subjected to chlorinated water in public and private pools or salt water environments found in marine and waterfront applications, Aquagrate will offer years of low cost, low maintenance service.

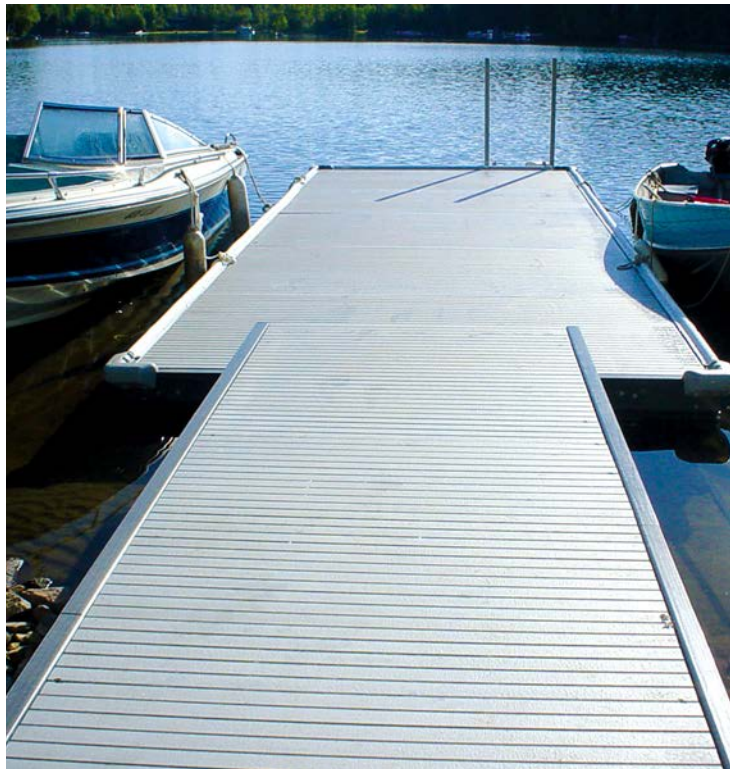

Dynaplank Boardwalk Plank

Dynaplank Boardwalk Plank is the perfect solution to your boardwalk, decking, and bridge needs. Fibergrate GRP Dynaplank is extremely durable yet very lightweight. Highly corrosive salt water air is no match for the corrosion-resistant properties of Fibergrate GRP Dynaplank and Dynaform structural supports. In addition, the lightweight properties make installation an ease, especially in remote areas where heavy machinery cannot be used. Dynaplank is 10-1/4" wide x 1-7/8" deep.



Dynaplank Boardwalk Plank Profile

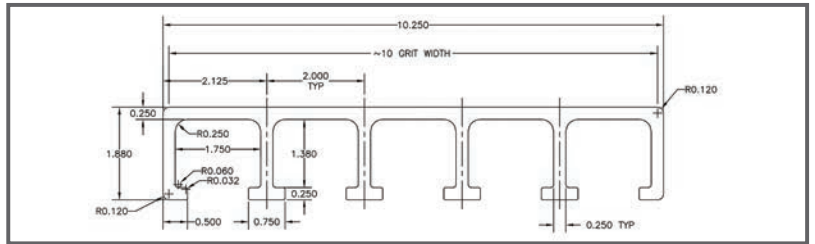

1.88" Deep Dynaplank Boardwalk Plank Load Span Table - Uniform Loads

Span (in)	Uniform Load (psf)									Max.Rec. Load (psf)	Ultimate Load (psf)
	50	65	100	150	200	300	500	1000	2000		
12	<0.01	<0.01	<0.01	<0.01	<0.01	<0.01	<0.01	<0.01	<0.01	40450	80900
24	<0.01	<0.01	<0.01	<0.01	<0.01	0.01	0.02	0.04	0.08	10110	20200
36	<0.01	0.01	0.02	0.03	0.04	0.05	0.09	0.18	0.35	4940	9800
48	0.03	0.03	0.05	0.08	0.11	0.16	0.27	-	-	3030	6000
60	0.06	0.08	0.12	0.18	0.25	0.37	-	-	-	1940	3800
72	0.13	0.17	0.26	0.38	-	-	-	-	-	1340	2600
84	0.24	0.31	0.47	-	-	-	-	-	-	990	1900

Values given are for a continuous installation of planks laid side by side.

1.88" Deep Dynaplank Boardwalk Plank Load Span Table - Line Loads

Span (in)	Line Loads (lb/ft of width)							Max.Rec. Load (lb/ft)	Ultimate Load (lb/ft)
	50	100	200	300	500	1000	2000		
12	<0.01	<0.01	<0.01	<0.01	<0.01	<0.01	<0.01	20220	40450
24	<0.01	<0.01	<0.01	<0.01	0.02	0.03	0.07	10110	20220
36	<0.01	<0.01	0.02	0.03	0.05	0.09	0.19	7410	14830
48	0.01	0.02	0.04	0.06	0.11	0.21	0.42	6060	12130
60	0.02	0.04	0.08	0.12	0.20	0.39	-	4850	9700
72	0.03	0.07	0.14	0.20	0.34	-	-	4040	8090
84	0.05	0.11	0.22	0.32	-	-	-	3460	6930

Values given are for a continuous installation of planks laid side by side. To calculate the deflection of a single plank multiply the values above by 1.17. To calculate the Max. Rec. or Ult. Load, multiply values by 0.85.

Dynarail Guardrail and Handrail

Dynarail Modular Guardrail and Handrail

Dynarail modular guardrail and handrail provide the look and performance of a custom rail system in an easily assembled, cost-effective package. Available in easy-to-use kits, the modular kits include step-by-step installation instructions. Dynarail is expertly engineered to use the fewest number of railing components of any system available in order to facilitate an easier, faster installation with less chance of error. Kits include everything needed for a quality installation requiring only minimal assembly skills, less labour and common hand tools. Posts are pre-routed to accept continuous rails, eliminating the need for extra pieces to connect rails to posts. Utilizing modular kits eliminates time-consuming fabrication and field modification associated with using stock lengths.



Dynarail Unique Guardrail and Handrail Solutions

Fibergrate has the capability to turnkey (design, manufacture, fabricate and install) a wide range of railing projects, from the smallest platform to massive, complex structures; from basic stairways to ADA compliant systems. To meet the requirements presented by such projects, Fibergrate employs a staff of engineers and technicians highly experienced in computerized design. This design group, well versed in all phases of GRP railing mounting conditions and special connections, provides the Fibergrate customer with accurate, concise drawings that meet the specifications of the project.

Fibergrate can also offer design, engineering, fabrication and installation of specialty solutions and picketed guardrail, segmented platform railings and other special systems.



Applications

Docks



Recommended Products

Product	GRP Advantage
Aquagrate® - Durable, Barefoot-Friendly, Anti-Corrosion	Docks and Piers made with our Corvex® Resin System will protect against UV damage and water corrosion, and be easy to install.
Micro-Mesh® - Bidirectional Strength, Low Maintenance	

Decks & Balconies



Recommended Products

Product	GRP Advantage
Aquagrate® - Looks Great, Easy Installation, Fire-Retardant	Marinas, decks and balconies made with Corvex® Resin and Aquagrate® will not hurt bare feet, and can be easily installed and maintained.
Dynarail® - UV-Resistant, Non-conductive	

Boardwalks



Recommended Products

Product	GRP Advantage
Ecograte® - Meets Army Corps of Engineers Requirements, Easy Installation, Low Maintenance, ADA Compliant.	Ecograte® is perfect for constructing boardwalks because it is not harmful to seagrass or the valuable habitat it provides.

Sunscreens

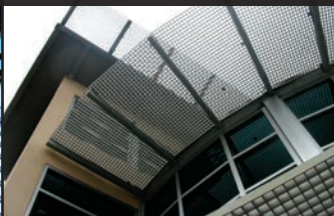
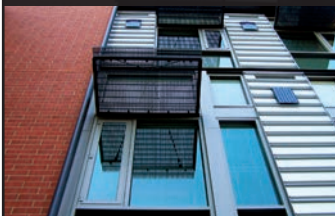

Recommended Products

Product	GRP Advantage
Moulded Square Mesh Grating- Low Maintenance, Easy Installation, Corrosion-Resistant	Fibergrate Corvex® Resin System will protect sunscreens from UV damage and weather related damage.

Stairs & Handrails

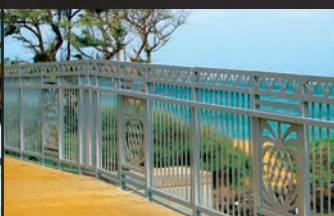
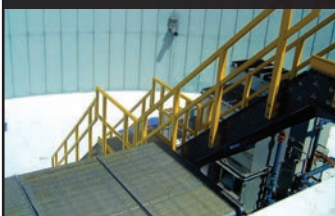

Recommended Products

Product	GRP Advantage
Dynarail® - Easy Installation, UV-Resistant, Non-conductive, Complete Customization	Dynarail® stair and handrail systems are resistant to UV and weather damage, and can be modified to include logos or unique shapes.

Sun Shades Are A Low Maintenance Way To Provide Shade, As Well As A Design Feature



Balconies Made Of FRP Are Safe, Long Lasting And Easy To Install



Grating Can Be Used As A Screen To Hide Unsightly Equipment And Storage



WATERSIDE MARINA & YACHT CLUB

Dynarail® Handrails and Stairways Can Be Customized To Any Job



Aquagrate® Is A Great Option Where Pedestrians May Be Barefoot



Ecograte® Helps Preserve Natural Sea Grass And Exceeds Guidelines Set By The Army Corps Of Engineers



Micro-Mesh® Looks Great And Its Bidirectional Strength Makes It A Versatile Option



Fibergrate Products & Services

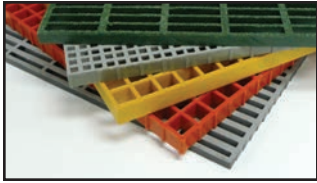

Fibergrate® Moulded Grating

Fibergrate® moulded gratings are designed to provide the ultimate in reliable performance, even in the most demanding conditions. Fibergrate offers the widest selection in the market with multiple resins and more than twenty grating configurations available in many panel sizes and surfaces.



Safe-T-Span® Pultruded Industrial and Pedestrian Gratings

Combining corrosion resistance, long-life and low maintenance, Safe-T-Span® provides unidirectional strength for industrial and pedestrian pultruded grating applications.

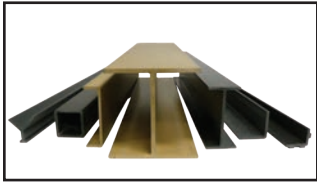

Dynaform® Structural Shapes

Fibergrate offers a wide range of standard Dynaform® pultruded structural profiles for industrial and commercial use, including I-beams, wide flange beams, round and square tubes, bars, rods, channels, leg angles and plate.



Dynarail® Handrail & Safety Ladder Systems

Easily assembled from durable components or engineered and prefabricated to your specifications, Dynarail® handrail and safety ladder systems meet or exceed OSHA and strict building code requirements for safety and design.

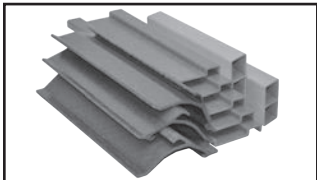

Custom Composite Solutions

Combining Fibergrate's design, manufacturing and fabrication services allows Fibergrate to offer custom composite solutions to meet our client's specific requirements. Either through unique pultruded profiles or custom open moulding, Fibergrate can help bring your vision to reality.



Design & Fabrication Services

Combining engineering expertise with an understanding of fibreglass applications, Fibergrate provides turnkey design and fabrication of fibreglass structures, including platforms, catwalks, stairways, railings and equipment support structures.



Worldwide Sales & Distribution Network

Whether a customer requires a platform in a mine in South Africa to grating on an oil rig in the North Sea, or walkways in a Wisconsin cheese plant to handrails at a water treatment facility in Brazil; Fibergrate has sales and service locations throughout the world to meet the needs and exceed the expectations of any customer.

Fibergrate Composite Structures Inc. believes the information contained here to be true and accurate. Fibergrate makes no warranty, expressed or implied, based on this literature and assumes no responsibility for the consequential or incidental damages in the use of these products and systems described, including any warranty of merchantability or fitness. Information contained here can be for evaluation only. The marks and trade names appearing herein, whether registered or unregistered, are the property of Fibergrate Composite Structures Inc.



Building the World to Last®

©Fibergrate Inc. 2011 Part No. GRP-Decks-and-Docking-Market-Solutions.UK.pdf
Printed in the USA

fibergrate.uk | (800) 527-4043

Fax: (972) 250-1530 | Email: info@fibergrate.com